

*To ensure personal safety and avoid damage to equipment, follow all safety instructions (Section 4).*

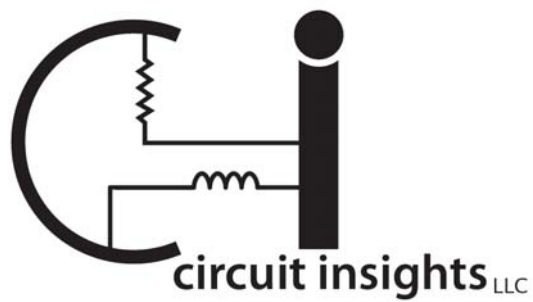

## E-200/D-285 Instruction Manual ©

Version 2.1  
March 21, 2011



*To ensure personal safety and avoid damage to equipment, follow all safety instructions (Section 4).*

**TABLE OF CONTENTS**

**1. INTRODUCTION: WHAT IS A GROUND LOOP? .....3**

**2. PRACTICAL ISSUES ASSOCIATED WITH GROUND LOOPS .....4**

**3. LOOP SLOOTH™ OVERVIEW .....5**

**4. SAFETY INSTRUCTIONS.....7**

**5. ROGOWSKI COIL CARE INSTRUCTIONS .....7**

**6. TUTORIAL – QUICK START .....8**

**7. WHAT IS MEANT BY THE *LOCATION* OF A GROUND LOOP? ..... 10**

**8. BASIC PROCEDURE: FINDING A SIMPLE GROUND LOOP ..... 10**

**9. MORE COMPLEX SITUATIONS: ..... 12**

1) Which of many cables carries the ground loop ..... 12

2) Multiple paths for ground loop currents ..... 12

3) Floating circuits..... 13

**10. METHODS FOR REMOVING GROUND LOOPS ..... 13**

**11. GROUND LOOP SURVEILLANCE..... 14**

**12. BATTERY REPLACEMENT AND BATTERY LIFE ..... 15**

**13. DETECTOR METER CALIBRATION AND EXCITER POWER ..... 15**

**14. REFERENCE AND PATENT INFORMATION ..... 16**

**15. IMPORTANT NOTICES ..... 16**

**16. FCC COMPLIANCE STATEMENT ..... 17**

**17. LOOP SLOOTH™ SPECIFICATIONS ..... 18**

## 1. Introduction: what is a ground loop?

Electronics is based on Kirchoff's voltage law which states that the sum of all voltages around a closed loop is zero. A trivial example is shown in Fig. 1(A) where six resistors are connected in a loop with no battery. Since there is no battery, the voltage across each resistor is zero and, in particular, no voltage will be measured at the test point connected across R1. However, Kirchoff's voltage law is only true for static situations. In time-dependent situations, Kirchoff's voltage law is superseded by Faraday's law of induction which states that the sum of voltages around a closed loop equals the rate of change of the magnetic flux linked by the loop. This is illustrated in Fig. 1(B) where the shaded circle represents time-dependent magnetic flux linked by the closed loop of resistors. Now there will be a voltage drop across the resistors and in particular a voltage will be measured at the test point connected across R1.

Now suppose that R1 is the shield (ground side) of a cable that goes from a microphone to an amplifier. The voltage across R1 will add to whatever voltage the microphone produces and so the voltage measured at the test point in Fig.1(C) will be the sum of these voltages. If the time-dependent magnetic flux oscillates at 60 Hz, the voltage produced across R1 by this oscillating flux will also be 60 Hz and so there will be a 60 Hz hum superimposed on the microphone signal. If the ground loop is broken, for example by disconnecting the bottom of resistor R6 as illustrated in Fig.1(D), the time-dependent magnetic flux no longer causes a voltage to appear across R1 and so the hum goes away.

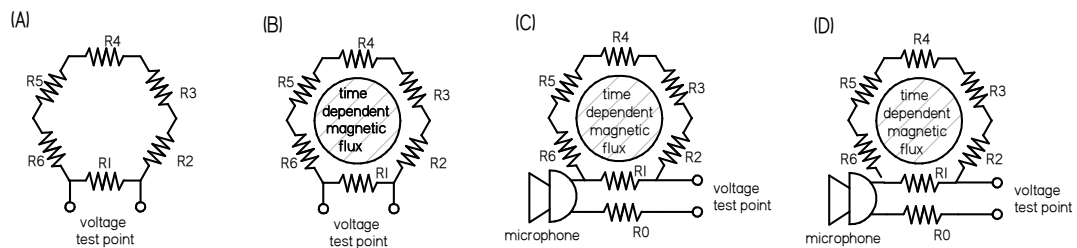
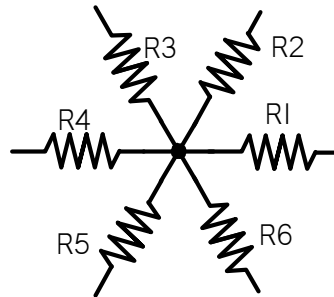

Figure 1 (A) no voltage across R1 in static situation, (B) voltage appears across R1 if loop links time-dependent magnetic flux, (C) field in cable shield adds to microphone voltage, (D) breaking of ground loop.

**Summary:** If the system of cable shields (ground wires) in a configuration forms a closed loop as in Fig. 1(A), then a time-dependent magnetic flux linking this loop, as in Fig. 1(B) will cause voltage drops to appear along the cable shields. These magnetically induced voltage drops in the cable shields will add to the voltage produced by any sensor, such as the microphone shown in Figs. 1(C) and (D). This is a ground loop.

## 2. Practical issues associated with ground loops

Grounding arrangements required for conformance with electrical safety codes often cause ground loops to be introduced. It is sometimes challenging, but never impossible, to satisfy safety requirements and yet avoid ground loops. Ground loops are often introduced by poor system design or by seemingly innocuous extraneous connections to ground. The definitive way to avoid ground loops is to use a star-grounding system as shown in Fig. 2; the resistors represent the shields (ground wires) of cables and the central dot represents the common ground. In this system there is a single ground point so no loop exists.



**Figure 2.** Star grounding system: ground cables of all devices are connected to central point which is connected to building ground.

In order to prevent the possibility of electric shock, electrical safety codes require grounding of all exterior metallic surfaces of electrical and electronic devices. Typically the power cord of a device has a third wire connecting the device chassis to building ground; this third wire is represented as R1 for device A and R3 for device B in Fig.3. Alternatively, device B could be an unpowered sensor such as a thermocouple and R3 could represent an accidental short to ground.

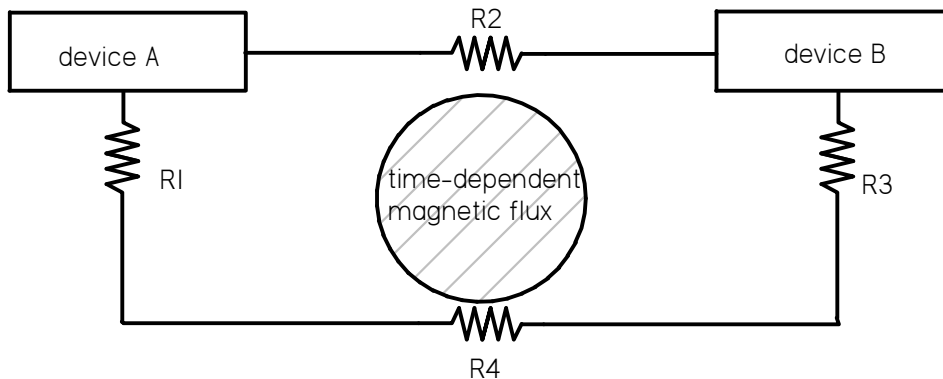

Figure 3. Ground loop when two grounded instruments are connected together by cable with ground wire (shield), resistor R4 represents ground wires in building, resistors R1 and R3 are ground wires in power cables of devices A and B, resistor R2 is shield of interconnecting cable. R3 could also be an accidental short to ground of shield of an unpowered sensor represented by device B.

Grounding the chassis of a device provides safety because any internal fault causing application of line (mains) voltage to the chassis would immediately cause a fuse to blow or a circuit breaker to trip. The fuse or circuit breaker would thus prevent line voltage from appearing on the chassis and providing a shock hazard. When grounded devices are interconnected to exchange signals, the shields of interconnecting cables can connect the ground of one device to the ground of another. This interconnection of grounds is shown by R2 in Fig.3. It is seen that the circuit R1-R2-R3-R4-R1 forms a loop, where R4 is the ground system. If this ground loop is linked by a time-dependent magnetic flux as shown in Fig. 3, a time-dependent voltage will be established around the loop and voltage drops will develop between different points on the ground loop. The time-dependent magnetic field linking the loop could be caused by many different types of sources. Common examples are fluorescent light fixtures, electric motors, power transformers, switching power supplies, and AC currents in nearby circuits. The induced voltage drops will have waveforms related to the time-dependence of the magnetic source and will interfere with desired signals. Because ground loops depend on linked magnetic flux, they depend on the physical arrangement of the wiring. Ground loops are often very difficult to track down. Being a loop they are inherently non-localized. If the magnetic source is transient, the interfering signal will also be transient and so will be an elusive 'glitch'. Ground loops are often a serious issue when small signals are being measured from multiple sensors (e.g., thermocouples, optical detectors, microphones, accelerometers) because spurious grounding of just one sensor can affect the integrity of the entire system.

A traditional method for finding ground loops is to disconnect all cables and then re-connect them one-by-one until the ground loop re-appears. This approach is not only tedious but may not work because disconnecting cables might disable the configuration being examined. For example, if the ground loop results from one set of cables inducing a current in another, then disconnecting all the cables will make it impossible to find the ground loop.

### **3. Loop Slooth™ E-200/D-285 overview**

The Loop Slooth™ E-200/D-285 provides a quick, logical, and efficient means for diagnosing the ground loops in a system. An important feature is that no cable has to be disconnected. This is because the Loop Slooth™ does not physically contact the system under test.

The Loop Slooth™ E-200/D-285 consists of an E-200 Exciter module and a D-285 Detector module, each having its own battery and power switch. The Exciter module creates a time-dependent (100 kHz) magnetic flux linked to the ground loop via a clamp-on current transformer if the loop exists. This linked time-dependent magnetic flux drives a 100 kHz test current in the ground loop. The Detector module measures the strength of this test current via an openable Rogowski coil that also links the ground loop. Figure 4 shows the D-200 Exciter module on the left and the D-285 Detector module on the right. The D-200

*To ensure personal safety and avoid damage to equipment, follow all safety instructions (Section 4).*

Exciter module has a power switch, green light emitting diode (LED) power-on indicator, and the clamp-on current transformer. The D-285 Detector module has a power switch, green power-on indicator LED, red ground loop indicator LED, digital meter, and Rogowski coil. Figure 5 shows the D-285 Rogowski coil untucked from its retainer at the top of the module.

The Exciter current transformer is linked to the power cord of an instrument to drive a test current in the power cord ground wire if this wire is part of a ground loop. The Detector provides a quick visual indication of presence of a ground loop via the red indicator LED. The Detector also has a digital meter for a more quantitative measurement.



**Figure 4. Left: D-200 Exciter, Right: D-285 Detector with Rogowski coil tucked in retainer at top of module.**



**Figure 5. D-285 Detector with Rogowski coil untucked.**

*To ensure personal safety and avoid damage to equipment, follow all safety instructions (Section 4).*

## 4. Safety Instructions



1. NEVER OPERATE, USE OR HANDLE ANY ELECTRICAL EQUIPMENT IN A MANNER INCONSISTENT WITH ITS OPERATING OR SAFETY INSTRUCTIONS. ALWAYS FOLLOW ALL SAFETY CAUTIONS AND INSTRUCTIONS PROVIDED BY THE MANUFACTURER OF YOUR OTHER ELECTRICAL EQUIPMENT WHILE USING THE LOOP SLOOTH™. IF YOU ARE UNSURE ABOUT THE SAFE HANDLING, USE OR OPERATION OF YOUR ELECTRICAL EQUIPMENT, CONTACT THE MANUFACTURER AND OBTAIN ALL INFORMATION YOU NEED. CIRCUIT INSIGHTS LLC IS NOT RESPONSIBLE FOR YOUR SAFE OPERATION, USE AND HANDLING OF ANY EQUIPMENT NOT MANUFACTURED BY CIRCUIT INSIGHTS LLC.



2. NEVER DISCONNECT THE POWER SAFETY GROUND OF ANY INSTRUMENT AS THIS WOULD DISABLE THE PROTECTION PROVIDED BY THE SAFETY GROUND AND MAKE USERS VULNERABLE TO POSSIBLE SHOCK AND ELECTROCUTION IN THE EVENT OF A FAULT. GROUND LOOPS SHOULD ONLY BE REMOVED BY CHANGING THE CONFIGURATION OF SIGNAL-LEVEL CABLES CONNECTED TO INSTRUMENTS OR DEVICES.



3. THE LOOP SLOOTH™ IS INTENDED TO TRACE CURRENTS FLOWING IN GROUND CONDUCTORS AND SHOULD ONLY BE LINKED TO CABLES HAVING GROUNDED SHIELDS, TO INSULATED POWER CORDS CONTAINING A GROUND WIRE, AND TO STRUCTURES SUCH AS PIPES THAT ARE GROUNDED. DO NOT LINK THE LOOP SLOOTH™ TO ANY OTHER TYPE OF CONDUCTOR. DO NOT LINK THE LOOP SLOOTH™ TO UNGROUNDED CABLES AS HAZARDOUS VOLTAGES MAY BE PRESENT.



4. DO NOT USE THE LOOP SLOOTH™ ON AN OPERATING PULSED POWER SYSTEM. EVEN THOUGH CABLES ARE GROUNDED, LARGE TRANSIENT GROUND LOOP VOLTAGES PRODUCED BY PULSES COULD ENDANGER THE OPERATOR OF THE LOOP SLOOTH™ AND COULD DAMAGE THE LOOP SLOOTH™ EXCITER OR DETECTOR.

## 5. Rogowski coil care instructions



The Rogowski coil (top of detector module) should not be cut, abraded, squeezed, or handled by tools as this could damage the large number of turns of fine wire that make up this coil. The Rogowski coil should only be handled manually and only tucked into or untucked from its retainer so as to link or unlink it from the cable or set of cables under test.

## 6. Tutorial – quick start

Units are shipped with batteries installed and are ready to use. Turn off when not in use to preserve battery life.

Take an isolated cable (coax, wire, extension cord) that is 10-50 feet long and connect one end to the other to form a test loop as sketched in Fig. 6. This test loop represents a ground loop such as may exist when two instruments are plugged into a wall outlet and have one or more interconnecting cables with ground wires.

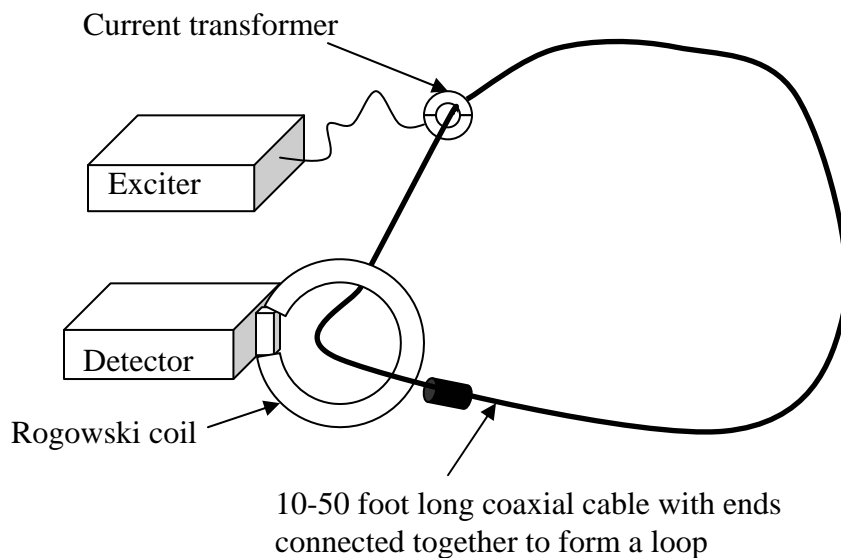

**Figure 6.** Basic setup: Exciter drives current in loop; Detector detects this current; loop must exist.

Clamp the Exciter module transformer around the cable so it is linked to the cable as in Fig. 6.

Holding the Detector module with its meter facing you, gently remove the end of the Rogowski coil nearest you from its retainer (see photos in Figs. 4 and 5). Arrange the Rogowski coil to link the cable and tuck the free end of the Rogowski coil back into its retainer.

The set-up should now have both the Exciter clamp-on transformer and the Detector Rogowski coil linking the test loop as in Fig.6. Turn on both the Exciter and Detector modules by depressing their power buttons. The green power LED indicators will illuminate on both modules.



The Detector module red ground loop indicator LED will illuminate and the meter will have a non-zero reading.

Break this test loop so that one end of the cable is no longer connected to the other. Note that the red LED on the Detector extinguishes and the meter reading goes to zero.

Re-establish the test loop so that the Detector LED re-illuminates. Turn off the Exciter and note that the Detector LED extinguishes. Turn the Exciter on again and unlink the Exciter from the test loop and note that the Detector LED extinguishes. Re-link the Exciter so that the Detector LED illuminates. Unlink the Detector and note that the Detector LED extinguishes.

The above operations show that the Detector red LED illuminates only when there is a closed loop and both Exciter and Detector link this loop.

With Exciter and Detector linked to the test loop and turned on so that the Detector LED is illuminated, coil up a portion of the test loop cable. Note that the Detector meter reading decreases as the coil is wound. This indicates that the Loop Slooth™ is sensitive to the loop inductance rather than to its resistance. The Loop Slooth™ sensitivity is such that a forty foot RG/58 coaxial cable, a typical cable used in laboratories, when arranged in a circle will read approximately 300 on the meter with shorter distances reading higher, i.e., a twenty foot cable arranged in a circle will read 600. The red LED illuminates for meter readings exceeding approximately 70, corresponding to an approximately 150 foot length of RG/58 arranged in a circle. The meter reading will increase if the area enclosed by the cable decreases and will decrease if the cable is coiled.

Arrange for the Rogowski coil to link two turns of the coiled cable. Note that the Detector module meter reading doubles indicating that twice as much current is being linked by the Rogowski coil. This doubling shows that the Detector meter reading is proportional to the amount of current flowing in the loop.

Linking the Exciter to the loop is equivalent to cutting the cable loop at a point and splicing into the cut an approximately 0.3 V amplitude 100 kHz signal generator with an  $R_i = 0.9$  Ohm internal impedance. If a loop exists and if the loop inductance is  $L$ , the applied voltage drives a loop current  $I = V/(R_i + i\omega L)$ . The Detector measures the magnetic field associated with this current and so the meter reading is proportional to  $I$ . A typical ground loop will have an inductance of the order of 10 microhenries and so will have an inductive reactance of approximately  $\omega L = 6$  Ohms which greatly exceeds  $R_i$ . The current driven in the ground loop will thus be approximately  $I = V/i\omega L$ .

## **7. What is meant by the *location* of a ground loop?**

Strictly speaking, one cannot say where a ground loop is located because a loop does not have a specific location. This is true if the ground loop is a result of poor design or cable arrangement. One can simply determine which system of cables comprises the ground loop and then the arrangement must be changed to eliminate the loop.

On the other hand, ground loops often occur because of an accidental short to ground of a conductor that is already grounded elsewhere. For example the BNC connector of a coaxial cable might accidentally touch a grounded metal surface and so establish a loop; the resistance of the touching point would correspond to  $R_3$  in Fig.3. Such a loop is neither intended nor required, but nevertheless links spurious time-dependent magnetic fields and so produces interfering signals. The location of the accidental short to ground in this situation could be considered as the location of the ground loop.

## **8. Basic procedure: finding a simple ground loop**

The basic procedure for finding a simple ground loop consists of the following two steps:

- 1) As sketched in Fig. 7, both the Exciter and Detector modules are first linked to the power cord of an instrument suspected of belonging to a ground loop. A ground loop exists if the Detector LED illuminates when both Exciter and Detector are powered on. The meter reading is noted; this indicates how much current is being driven in the ground loop by the Exciter module.
- 2) The Exciter is kept linked to the power cord and turned on. As shown in Fig. 8, the Detector is then sequentially linked to all cables connected to the instrument. In the situation shown in Fig.8, linking one or both of cables a, b will cause the Detector LED to illuminate. The path of the ground loop is followed by linking the detector to the cable at successive points along the cable. If there is a junction, the Detector is linked to all the cables at the junction to determine the current path. The entire loop of any cable can be traced out in this manner and a determination can be made whether the loop is due to the system's intrinsic design or due to an accidental short to ground.

To ensure personal safety and avoid damage to equipment, follow all safety instructions (Section 4).

Step 1

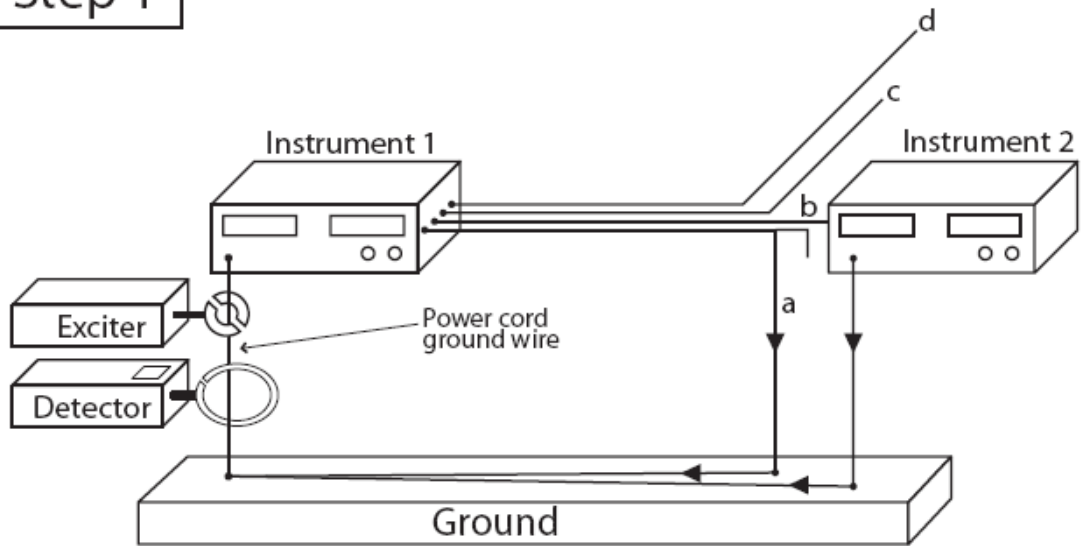

**Figure 7** Step1: To check whether Instrument 1 has a ground loop, both Exciter and Detector are linked to power cord of Instrument 1. In this example there are ground loop paths through cables a and b. Cable a has accidental short to ground. All wires shown are ground or shield wires.

Step 2

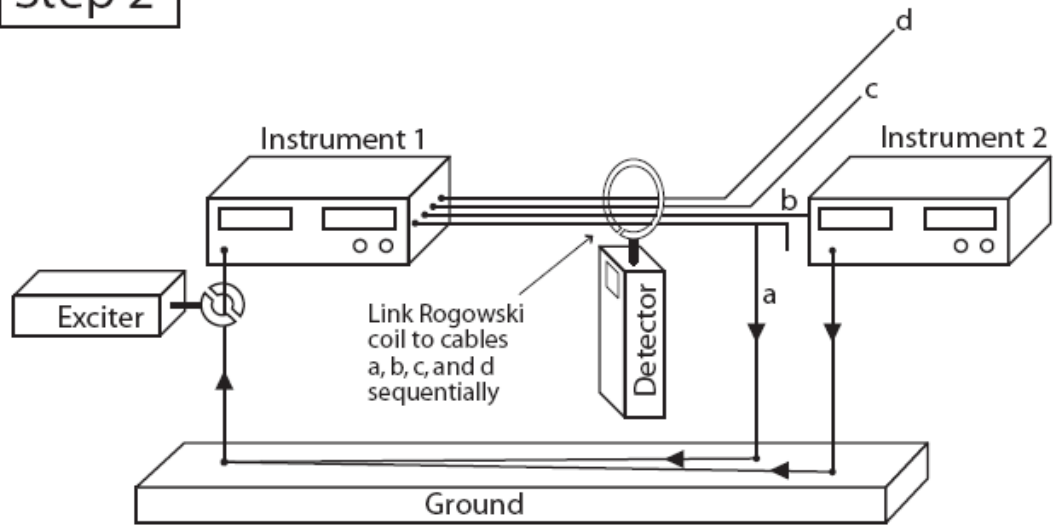

**Figure 8** Step 2: The identity of the cable(s) involved in the ground loop is determined by linking the Detector Rogowski coil sequentially to cables a, b, c, and d. When the Rogowski coil links one or both of cables a and b, the Detector LED will illuminate indicating presence of ground loop current driven by Exciter. If the Rogowski coil links neither a nor b, then the indicator will not illuminate. The meter provides information on the relative amounts of ground loop current flowing in a and in b. All wires shown are ground or shield wires.

To ensure personal safety and avoid damage to equipment, follow all safety instructions (Section 4).

## **9. More complex situations:**

### **1) Which of many cables carries the ground loop**

An instrument might be connected to a very large number of cables, only one or a few of which are involved in ground loops. An example of this situation would be a data logger connected to a 128 identical thermocouples, one of which has an accidental short of its shield to building ground somewhere on its long connecting cable. In such a situation, linking the Detector sequentially to each of the 128 thermocouple cables would be very time-consuming. Diagnosis can be greatly accelerated by using a binary reduction method. Divide the set of 128 cables into two groups, called group A and group B, each with 64 cables. Link the Rogowski coil first to group A and, next, to group B. If the Detector LED illuminates for group A, but not for group B, then the ground loop must be in group A. Divide group A into group C and group D, each with 32 cables. Link the Rogowski coil to group C and then to group D. If the LED illuminates for group D, then the ground loop is in group D. Repeat this procedure until the offending cable is found. If there are  $2^N$  cables, this method will locate the offending cable in N steps.

### **2) Multiple paths for ground loop currents**

The ground loop current might separate into two or more paths in a manner analogous to water flowing in a large pipe dividing to flow into two or more smaller pipes. The meter provides a means for tracking this splitting of the current flow. Suppose the Detector meter reads 500 when both Exciter and Detector are linked to the instrument power cord. If as shown in Fig. 8, linking the Detector to one suspect cable provides a meter reading of 400 and linking it to another cable provides a meter reading of 100, this means that the ground loop subdivides into two branches, one carrying 80% of the ground loop current and the other carrying 20%. Eliminating the large-current branch will typically force all the ground loop current to flow in the remaining branch. Thus, fixing one segment of a ground loop may make another segment worse because the ground loop current is diverted to flow in the other segment. One can get into a situation of chasing the ground loop around the system since it will seem to disappear from one part of the circuit and re-appear in some other part like an elusive ghost. Whether or not this happens depends on the impedance of the branches compared to the impedance of the entire loop. The branch impedances  $Z_1$ ,  $Z_2$  in a typical situation are small compared to the impedance  $Z_R$  of the remaining part of the loop so  $Z_R$  constitutes most of the

loop impedance. In this case the driven current is approximately  $I=V/Z_R$  where  $V$  is the Exciter voltage. Thus, the  $Z_R$  part of the circuit acts as a current source, i.e., the total current  $I$  in the branches does not depend on the values of  $Z_1$  and  $Z_2$ . The current  $I$  is shared by  $Z_1$  and  $Z_2$  which are in parallel with 80% through  $Z_1$  and 20% through  $Z_2$ . If  $Z_1$  is removed (open-circuited), then 100% of the current will flow through  $Z_2$ . Thus eliminating the  $Z_1$  problem makes the  $Z_2$  problem worse. Once the  $Z_1$  ground loop has been removed, the  $Z_2$  ground loop must then be traced and fixed. This process of finding and eliminating successively higher impedance ground loops is continued until the Detector meter reads zero when linked to the instrument power cord. The situation where the ground loop current hops around is analogous to damming up one of two parallel streams at the base of a large waterfall so that all the water that previously flowed in the dammed-up stream is diverted to the stream that is not dammed up.

### 3) Floating circuits

A situation closely related to a ground loop is where a circuit intended to be floating is accidentally connected to ground at some unknown physical location. This ‘ground fault’ can be found by creating a temporary ground loop and then tracing the path of this loop. This is done by first turning off all power for safety and then using a temporary jumper cable to connect any part of the floating circuit to ground. The Exciter and Detector are linked to the jumper. Illumination of the Detector LED indicates presence of a loop involving the jumper cable. Since one end of the jumper cable is at ground, the loop must involve connection of some other part of the floating circuit to ground. The Detector is then moved around the circuit to trace the loop path and so locate the accidental connection to ground.

## 10. **Methods for removing ground loops**

Removing accidental short If the ground loop is accidental, e.g., caused by an unintentional connection of a cable shield to ground, then the ground loop is easily removed by removing the unintentional connection to ground.

Isolation transformer or optical link If the ground loop is not accidental, but rather the result of the circuit design, then the loop can be removed by inserting an isolation transformer or an optical break in the offending cable.

Removing linked magnetic flux The ground loop signal could be eliminated without removing the loop if the magnetic flux linking the loop is removed. For example, if the ground loop is due to an electric motor or transformer, the motor or transformer could be moved to a different location. If the source is a switching power supply, the power supply could be replaced by a linear power supply since

the latter does not produce time-dependent magnetic fluxes. Magnetic shielding could be used to divert the magnetic flux away from the ground loop.

Increasing inductance of loop path to decrease ground loop current The inductance of the ground loop current path can be increased without affecting the inductance of the path of the desired signal by wrapping a portion of the coaxial cable around shield beads, a ferrite core, or an iron-core transformer. This has the effect of increasing the impedance seen by the ground loop current without increasing the impedance seen by the desired signal current. The signal cable would be wrapped one or more times around the ferrite or iron core which then acts as an inductor in series with the common mode signal. Because inductance increases as the square of the number of turns, wrapping a large number of turns around a core can be very effective. While this method does not affect the desired signal, it becomes progressively less effective at attenuating the spurious signal as the frequency of the spurious signal is lowered. It is most suitable for protecting against fast transient glitches but less effective for low frequency hum.

Eliminating area linked by ground loop The area effectively linked by the ground loop could be made arbitrarily small by twisting signal cables around the power cables and have all instruments plugged into adjacent mains sockets. As an example, the signal cable interconnecting instruments A and B would start at A, be twisted around the A power cable going back to the mains outlet, then twist around the B power cable and then connect to its appropriate terminal on B. This scheme zeroes out the area linked by the loop so no stray magnetic flux is linked. The ground loop area is minimized by having instruments A and B plugged into adjacent power outlets. Minimizing the linked area would correspond to having resistor R2 moved to be below the shaded circle in Fig.3.

## **11. Ground loop surveillance**

In situations where the circuit arrangement is constantly being reconfigured such as research labs or studios, a good practice would be to check for ground loops after each re-arrangement. This could be accomplished by simply leaving the Exciter and Detector linked to an instrument power cord and turning on the Exciter and Detector to see if a ground loop has been established as a result of the last change in the configuration.

## 12. Battery replacement and battery life

Each module uses one 9 volt battery. Use only high quality alkaline batteries (Duracell MN1604 or equivalent). To replace batteries, use a Philips screwdriver to remove the silver-colored bolts holding down the back panels and remove the back panels of the Exciter and Detector Modules (see Fig. 9). Gently remove old batteries. Insert new battery in each module and then replace the back panels. Never undo the black bolts on the front or top panels as this will void warranty and re-assembly will be difficult or impossible.



Figure 9 Battery replacement.

The Exciter battery will last for about 2 hours of continuous operation and the Detector battery will last somewhat longer. To maximize battery life, both Exciter and Detector should be turned off when not in use. The Exciter output slowly declines as the battery wear out and at a critical voltage, frequency stabilization is lost at which point the Detector reading will become non-constant and declining. The battery condition can be determined by doing a test as in the Tutorial (Sec. 6).

## 13. Detector meter calibration and Exciter power

The meter on the Detector module reads approximately in units of 0.06 milliamperes (+-10%) peak current at 100 kHz, i.e., a reading of 1000 on the meter corresponds to the Exciter module driving approximately 60 mA peak current at 100 kHz through a ground loop. The nominal effective source impedance of the Exciter module with current transformer is 0.9 Ohm and the nominal open-circuit source voltage is 300 mV. This corresponds to 12 mW maximum output power (matched load) and 300 mA maximum output current (short circuit load). Since typical ground loops have an inductive reactance substantially exceeding 1 Ohm at 100 kHz, the current transformer can be considered to act as a 300 mV voltage source that is spliced into the ground loop circuit. The induced current and hence meter reading will scale inversely with the length of the ground loop path, but will also be affected by the cable diameter, the area linked by the cable path, any coiling up of the cable, nearby metal, and ferromagnetic material linking the cable such as shielding beads. Exciter power can be reduced by placing one or more sheets of paper in the jaw of the exciter current transformer so that it does not clamp completely shut. Sensitivity can be increased by wrapping the cable under test two or more times through the exciter current transformer or the detector Rogowski coil.

## 14. Reference and patent information

P. M. Bellan, *Simple system for locating ground loops*, Rev. Sci. Instrum. **78**, Art. No. 065104 (2007).

Tutorial on website [www.LoopSlooth.com](http://www.LoopSlooth.com) discusses the physics of ground loops.

US Patent No. 7,791,353 B2

## 15. Important notices

**CIRCUIT INSIGHTS LLC MAKES NO WARRANTIES, EXPRESS OR IMPLIED, INCLUDING, BUT NOT LIMITED TO FITNESS FOR A PARTICULAR PURPOSE. USER IS RESPONSIBLE FOR DETERMINING WHETHER THE PRODUCT IS SUITABLE AND SAFE FOR A PARTICULAR PURPOSE.**

**LIMITATION OF REMEDIES AND LIABILITY: IF THE PRODUCT BECOMES DEFECTIVE WITHIN ONE YEAR AFTER PURCHASE, THE EXCLUSIVE REMEDIES AT CIRCUIT INSIGHT LLC'S OPTION WILL BE TO REPAIR OR REPLACE THE DEFECTIVE PRODUCT WITH A NEW OR REFURBISHED PRODUCT. THIS REMEDY DOES NOT APPLY TO PRODUCTS THAT HAVE BEEN PHYSICALLY OR ELECTRICALLY DAMAGED OR ABUSED. CIRCUIT INSIGHTS LLC SHALL NOT OTHERWISE BE LIABLE FOR ANY LOSS OR DAMAGES, WHETHER DIRECT OR INDIRECT, SPECIAL, INCIDENTAL, OR CONSEQUENTIAL, REGARDLESS OF THE LEGAL THEORY ASSERTED, INCLUDING NEGLIGENCE, FAULTY DESIGN, UNCLEAR INSTRUCTIONS, WARRANTY, OR STRICT LIABILITY.**

**THE EXCITER AND DETECTOR MODULES ARE ASSEMBLED WITH TIGHT TOLERANCES. DO NOT REMOVE THE BLACK BOLTS ON THE FRONT (LED SIDE) OR TOP (ROGOWSKI COIL RETAINER) OF THE MODULES OR ATTEMPT TO REMOVE THE INTERNAL PRINTED CIRCUIT BOARDS AS IT WILL BE EXTREMELY DIFFICULT TO RE-INSERT THE BOARDS WITH CORRECT ALIGNMENT. THE REMEDIES LISTED IN THE PREVIOUS PARAGRAPH WILL BECOME VOID FOR MODULES WHERE ANY BLACK BOLTS OR CIRCUIT BOARDS HAVE BEEN REMOVED BY PARTIES OTHER THAN CIRCUIT INSIGHTS LLC.**



## **16. FCC Compliance Statement**

**Federal Communications Commission:** Verified to comply with FCC rules for Cable Locating Equipment, Part 15 Section 15.3(d) and Section 15.213, as reproduced below.

This device complies with Part 15 of the FCC Rules. Operation is subject to the following two conditions:

- (1) this device may not cause harmful interference, and
- (2) this device must accept any interference received, including interference that may cause undesired operation.

Note that FCC regulations provide that changes or modifications not expressly approved by Circuit Insights LLC could void your authority to operate this equipment.

### **Sec. 15.3 Definitions**

(d) Cable locating equipment. An intentional radiator used intermittently by trained operators to locate buried cables, lines, pipes, and similar structures or elements. Operation entails coupling a radio frequency signal onto the cable, pipes, etc. and using a receiver to detect the location of that structure or element.

### **Sec. 15.213 Cable locating equipment**

An intentional radiator used as cable locating equipment, as defined in Sec. 15.3(d), may be operated on any frequency within the band 9-490 kHz, subject to the following limits: Within the frequency band 9 kHz, up to, but not including, 45 kHz, the peak output power from the cable locating equipment shall not exceed 10 watts; and, within the frequency band 45 kHz to 490 kHz, the peak output power from the cable locating equipment shall not exceed one watt. If provisions are made for connection of the cable locating equipment to the AC power lines, the conducted limits in Sec. 15.207 also apply to this equipment.

## 17. Loop Slooth™ Specifications

<b>E-200 Exciter</b>	Excitation frequency	100 kHz
	Power switch	Pushbutton on/off
	Power on indicator	green LED
	Effective source impedance	0.9 Ohm
	Effective source voltage	0.3 volts amplitude
	Maximum output power	12 milliwatts
	Maximum output current	0.3 amps
	Battery	9 volt
	Battery life	2 hours
	Current Transformer bore	25 mm
	Current Transformer cable length	1 meter
	Case dimensions (box only)	132 mm x 55 mm x 66 mm
	Case material	flame retardant ABS
	Weight with battery	0.3 kg
	Environmental	indoor use only

<b>D-285 Detector</b>	Detection frequency	100 kHz
	Power switch	Pushbutton on/off
	Quick ground loop indicator	red LED
	Power on indicator	green LED
	Meter sensitivity (+-10%)	1 meter unit = 60 $\mu$ A
	Meter full scale (reads 1999)	120 mA (+-20%)
	Battery	9 volt
	Battery Life	2 hours
	Rogowski Coil bore	approximately 85 mm
	Case dimensions (box only)	132 mm x 55 mm x 66 mm
	Case material	flame retardant ABS
	Weight with battery	0.3 kg
	Environmental	indoor use only

[www.loopslooth.com](http://www.loopslooth.com)

circuit-insights@charter.net